

UA-S2F PILOT OPERATED POPPET, 2 WAY, NORMALLY CLOSED – SOFT SEAT

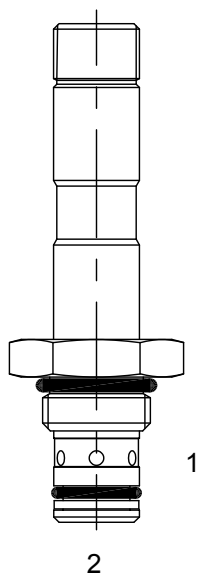

DESCRIPTION

7 size, 5/8-18 thread, "Mini" series, solenoid operated, 2 way normally closed, pilot operated soft seat poppet valve with reverse flow de-energized.

OPERATION

When de-energized the UA-S2F blocks flow from (1) to (2) and allows free reverse flow from (2) to (1). When energized, the valve allows flow from (1) to (2) and restricts flow from (2) to (1).

FEATURES

- Soft seat for ultra low leakage.
- Efficient wet-armature construction.
- Cartridges are voltage interchangeable.
- Industry common cavity.
- Unitized, molded coil design.
- Continuous duty rated solenoid.
- Optional coil voltages and terminations.

HYDRAULIC SYMBOL

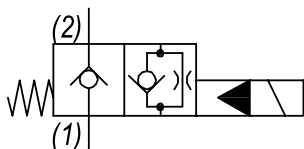

PERFORMANCE

Actual Test Data (Cartridge Only)

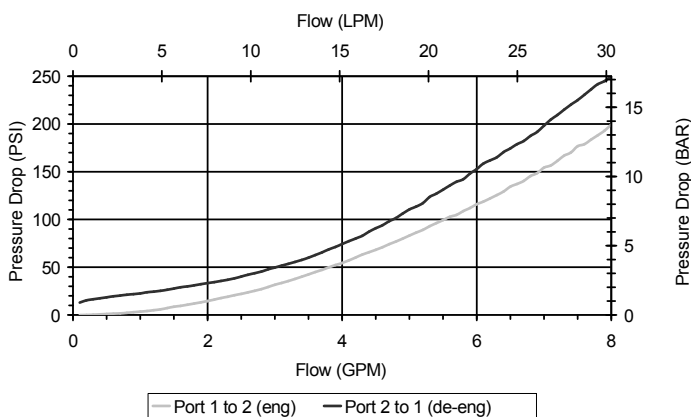

VALVE SPECIFICATIONS

Nominal Flow	4 GPM (15 LPM)
Rated Operating Pressure	3000 PSI (207 bar)
Typical Internal Leakage (150 SSU)	Negligible
Viscosity Range	36 to 3000 SSU (3 to 647 cSt)
Filtration	ISO 18/16/13
Media Operating Temp. Range	32° to 160°F (0° to 70°C)
Weight	.12 lbs (.05 kg)
Operating Fluid Media	General Purpose Hydraulic Fluid
Cartridge Torque Requirements	15 ft-lbs (20.3 Nm)
Coil Nut Torque Requirements	4-6 ft-lbs (5.4-8.1 Nm)
Cavity	MINI 2W
Cavity Form Tool (Finishing)	40500003
Seal Kit	21191000

WARNING: the specifications/application data shown in our catalogs and data sheets are intended only as a general guide for the product described (herein). Any specific application should not be undertaken without independent study, evaluation, and testing for suitability.



4484 Boeing Drive Rockford, IL 61109 • USA • Phone +1 (815) 397-6628 • Fax +1 (815) 397-2526
 mail: delta@delta-power.com • www.delta-power.com



Via Malavolti, 36 • 41122 Modena • ITALY • Phone +39 (059) 254895 • Fax +39 (059) 253512
 mail: tecnord@tecnord.com • www.tecnord.com

DIMENSIONS

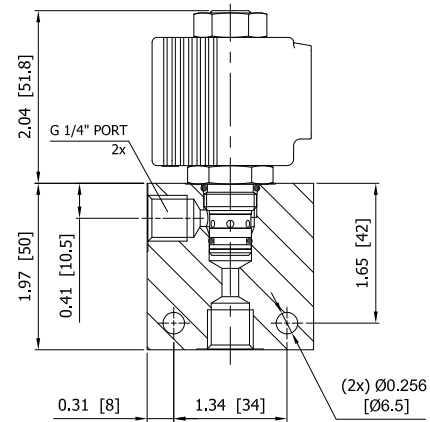
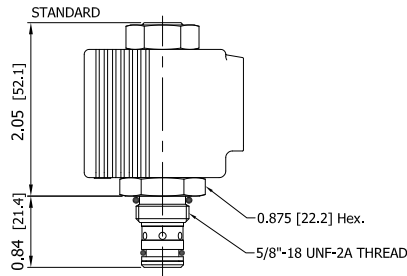
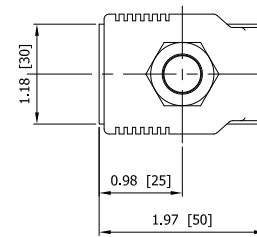
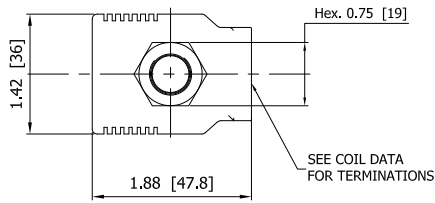

ORDERING INFORMATION

Approximate Coil Weight: .30 lbs (.14 kg)

UA-S2F - - - -

OPTIONS

- Buna Standard **00**
- Viton Standard **V0**
- Buna, Screen **A0**
- Viton, Screen **W0**

Note: use screen only if flow direction is from (1) to (2)

BODIES

- Blank Without Body
- N** 1/4" BSP Ports
- S** #6 SAE Ports

VOLTAGE (other voltages available on request)

- 12** 12 VDC
- 24** 24 VDC
- 26** 220 VAC with molded full wave rectifier

"P" TYPE "J" COIL TERMINATION

- JA** "J" Coil AMP Superseal - Integral
- JD** "J" Coil Deutsch - Integral DT04-2P

JJ "J" Coil AMP Jr. Time - Integral

- JL** "J" Coil Double Lead
- JH** "J" Coil DIN 43650 (Hirschmann)

W 40 / 2017

WARNING: the specifications/application data shown in our catalogs and data sheets are intended only as a general guide for the product described (herein). Any specific application should not be undertaken without independent study, evaluation, and testing for suitability.



4484 Boeing Drive Rockford, IL 61109 • USA • Phone +1 (815) 397-6628 • Fax +1 (815) 397-2526
 mail: delta@delta-power.com • www.delta-power.com



Via Malavolti, 36 • 41122 Modena • ITALY • Phone +39 (059) 254895 • Fax +39 (059) 253512
 mail: tecnord@tecnord.com • www.tecnord.com